



FRAMELESS DIFFUSERS
TECHNICAL CATALOGUE

ABOUT US

The original idea
makes design distinctive,
the function makes it work
and quality adds value



PRODUCERS OF GYPSUM AIR DIFFUSERS

We are the manufacturers of innovative, modern and elegant air diffusers, the first on the market to use a unique, patented design and our own gypsum composite. Air has never been so elegant. This phrase is the basic idea behind Ventmann's organization and growth.

OUR PURPOSE

To create, produce and supply new and innovative air solutions to our partners and clients. Our new generation of diffusers made of gypsum fully realise our company's purpose:

- They are innovative - the first on the market made from a special gypsum composite.
- They are also modern - their production process is flexible and environmentally friendly, while the installation possibilities are almost limitless.
- And finally, these air diffusers are elegant - they help maintain the integrity of the interior design and completely blend in with wall and ceiling surfaces.



LINE

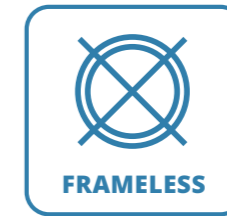

LINE model diffusers are an elegant and flexible interior design solution. Using this model, it's possible to create strikingly unique interior elements or, in contrast, make the diffuser almost invisible.

By selecting the right model size, it becomes easy to create interesting ceiling designs. Alternatively, it is also possible to create an illusion of no diffuser at all. That is achieved by opting for the SLIM model. In the event of form over function, our LINE diffusers can also be used as imitations, to create an endless line without breaks. This way, unique interior design solutions can be made real.

LINE diffuser models are more than just interior design elements, but a practical solution. They are the first diffusers on the market that can be painted with the same paint as the rest of the surface and leave no frames to look at. In addition, even standard LINE models can be adapted to your needs:

·1-slot, 2-slot or 3-slot types are available from LINE models.

·625mm; 1000mm; 1250mm - you can choose these standard lengths of the LINE diffuser models.

·12mm or 18mm - you can choose these standard slot widths of the LINE diffuser models.

Even standard diffuser models can be flexibly adapted to your needs. They can be connected in an infinite line with unobtrusive connections. These unique solutions do not require lowering of the ceiling height.

You can place all standard size orders in the order form below.

If your project requires non-standard solutions, or your market requires specific dimensions of LINE diffusers - we can help you.

Fill out the order form below and select a bespoke order. Our consultants will contact you and together we will discuss the fulfilment of your order.

We also invite you to get acquainted in detail with the technical information of LINE model diffuser, which you can do by reading through our catalogue.

Finally, to witness how easy it is to install LINE diffusers, we invite you to watch our product showcase video.

Ventmann - your choice of air elegance.



Installation:
video instructions
 YouTube



Download a digital
version of the catalog
 Download

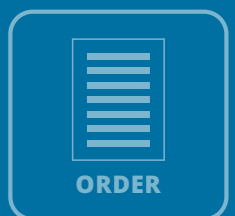
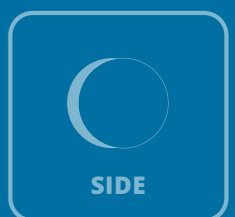
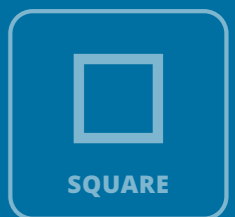

LINE 1/12

SLOT DIFFUSER

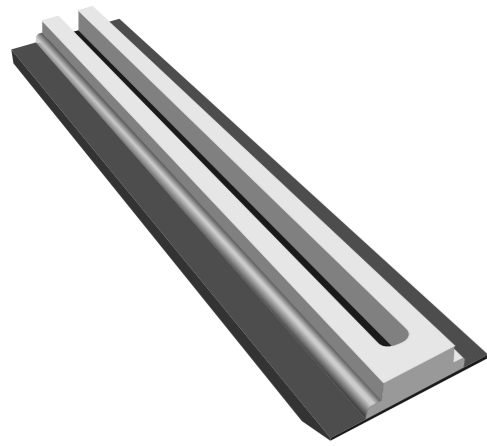

1
AMOUNT OF SLOTS

12 mm
WIDTH OF SLOT

2.5 kg
1 M. LENGTH DIFFUSER WEIGHT
WITHOUT PACKAGING (NET)

625 / 1000 / 1250
STANDARD SLOT LENGTH (MM)

Steel punched sheet. Distributes the air supply through the diffuser.

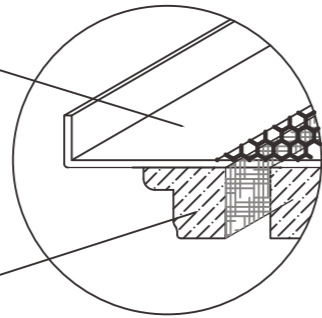

Gypsum mix segment. Sanded, puttied, painted. Suitable for all operations in combination with surface finishing

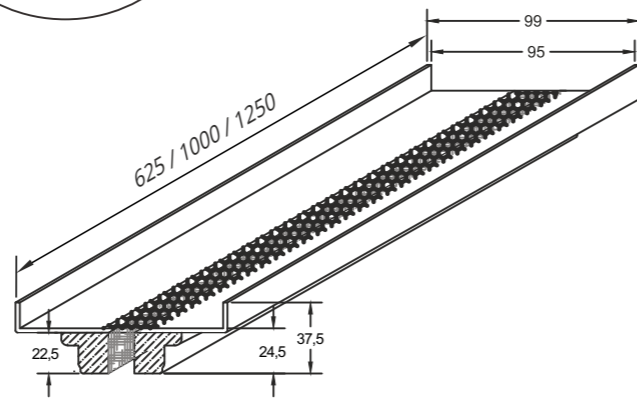
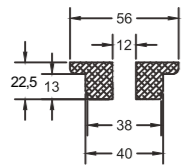

Slot narrower by a third, which is less noticeable indoors, is called the Slim version. When the gap is narrowed, the diffuser hardly loses its technical capabilities. Great choice for subtle integration of diffuser into minimalist spaces.

PERCEPTIBLE AIRSPEED $L_{0,2}(m)$ DISTANCE

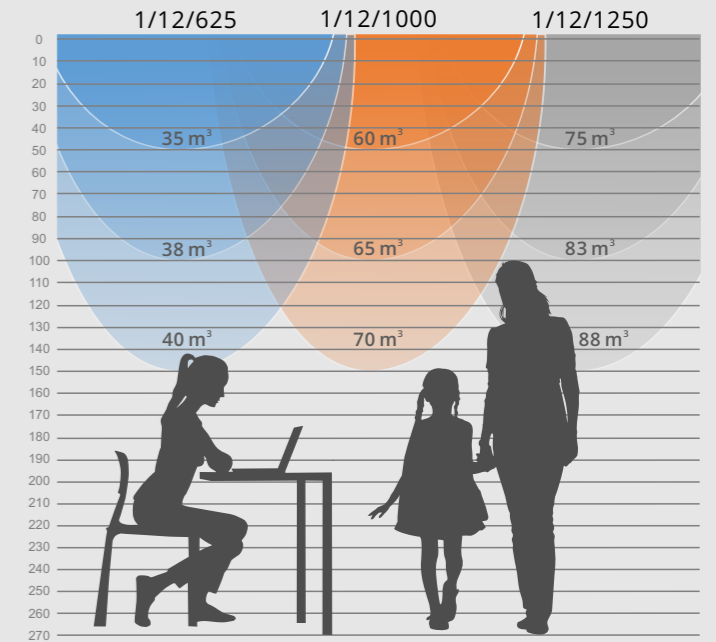

Airflow perceptible with the Line diffuser at a height of 2.70 m

PERCEPTIBLE AIRSPEED REACH LIMIT

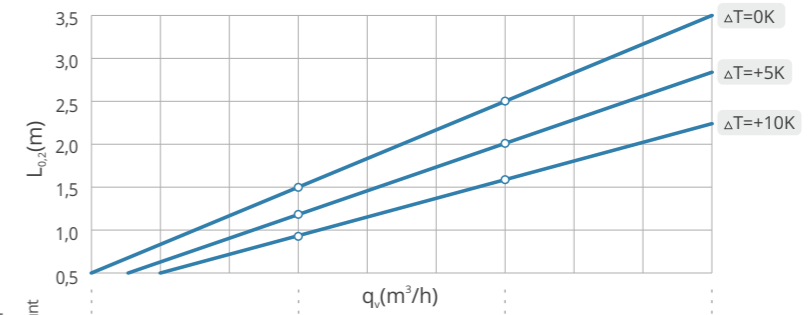

Order code:	35	40	45	50
LINE 625 1 12	35	40	45	50
LINE 1000 1 12	60	70	80	90
LINE 1250 1 12	75	88	102	115
LINE 625 1 18	35	40	45	70
LINE 1000 1 18	60	77	94	110
LINE 1250 1 18	75	97	118	140

Airborne noise and resistance, 1 m.

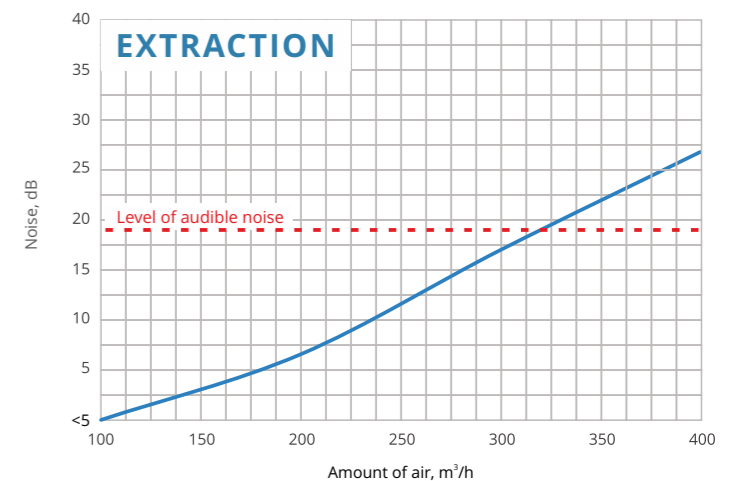
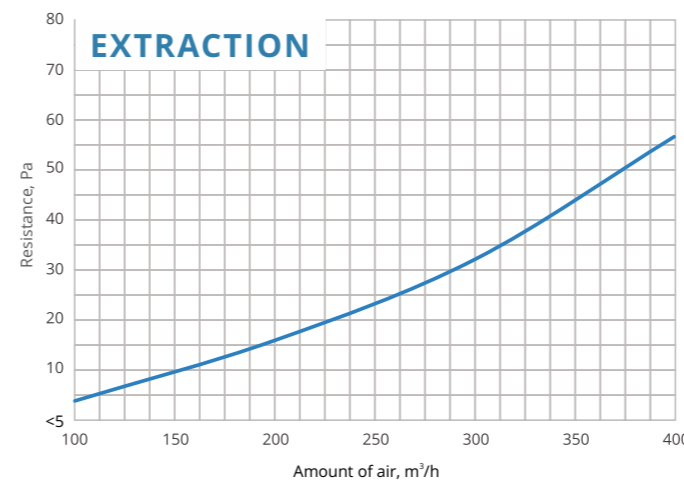
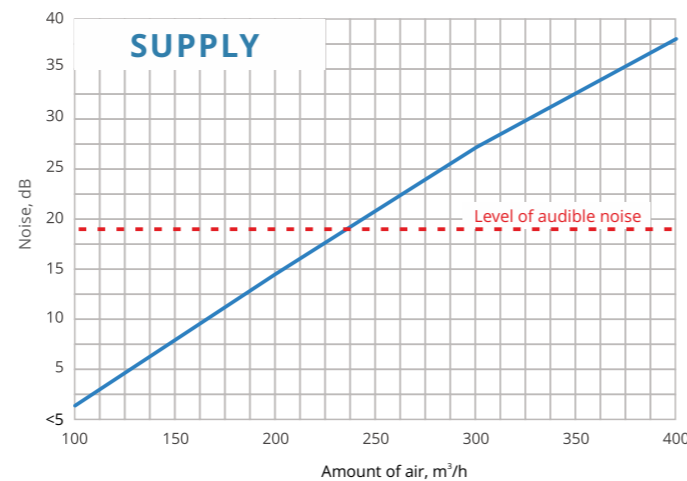
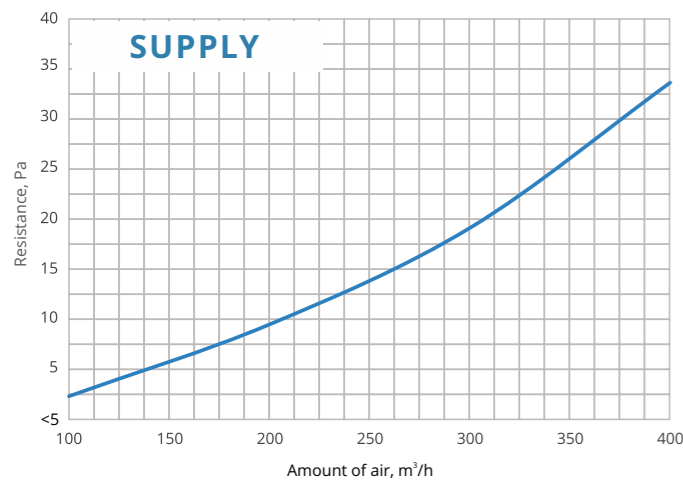

LINE 2/12

SLOT DIFFUSER

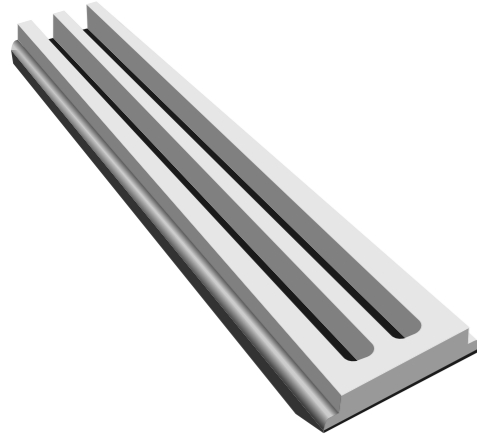

2
AMOUNT OF SLOTS

12 mm
WIDTH OF SLOT

2.735 kg
1 M. LENGTH DIFFUSER WEIGHT
WITHOUT PACKAGING (NET)

625 / 1000 / 1250
STANDARD SLOT LENGTH (MM)

Steel punched sheet. Distributes the air supply through the diffuser.

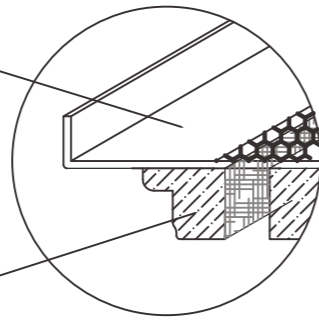

Gypsum mix segment. Sanded, puttied, painted. Suitable for all operations in combination with surface finishing

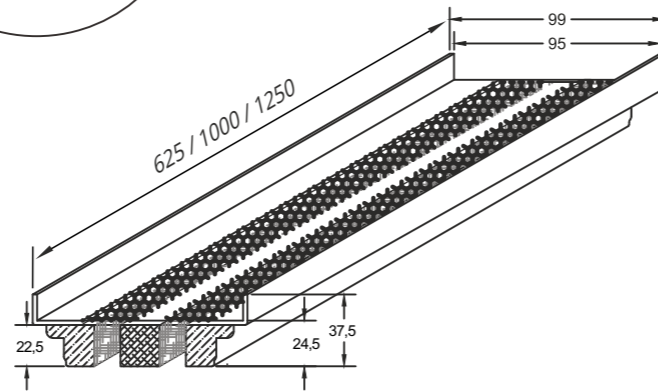
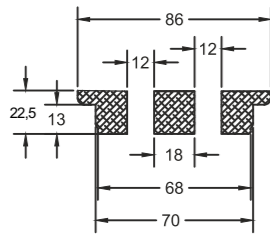

Slim slots are narrower by 30%, making them harder to spot in the environment. However, they do not compromise too much on functionality and aerodynamic properties. They are easily integrated into both walls and ceilings.

PERCEPTIBLE AIRSPEED $L_{0,2}(m)$ DISTANCE

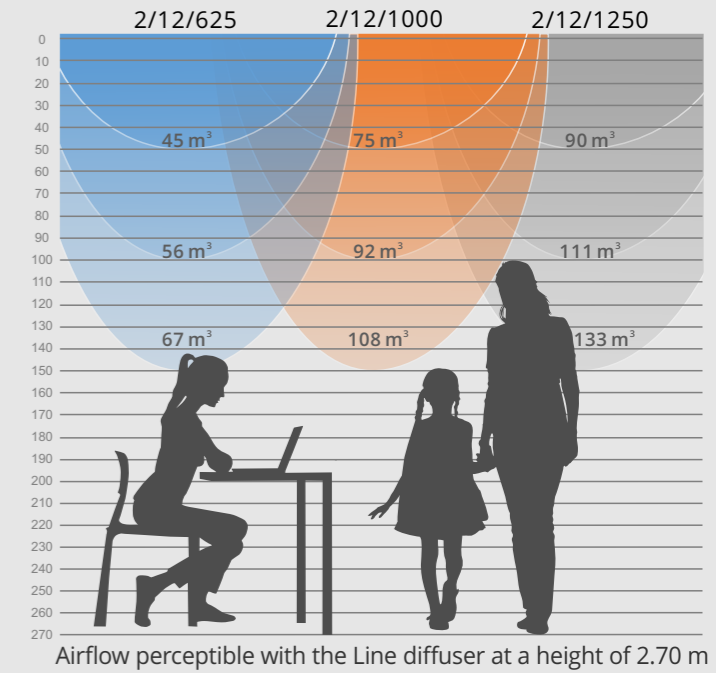

PERCEPTIBLE AIRSPEED REACH LIMIT

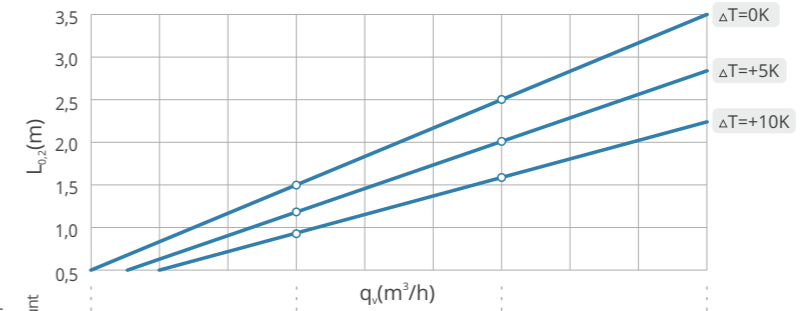

Order code:

Order code	slot length (mm)	amount (mm)	slot width (mm)	45	67	88	110
LINE 625 2 12	625	2	12	45	67	88	110
LINE 1000 2 12	1000	2	12	75	108	142	175
LINE 1250 2 12	1250	2	12	90	133	177	220
LINE 625 2 18	625	2	18	45	75	105	135
LINE 1000 2 18	1000	2	18	75	120	165	210
LINE 1250 2 18	1250	2	18	90	148	206	265

Airborne noise and resistance, 1 m.

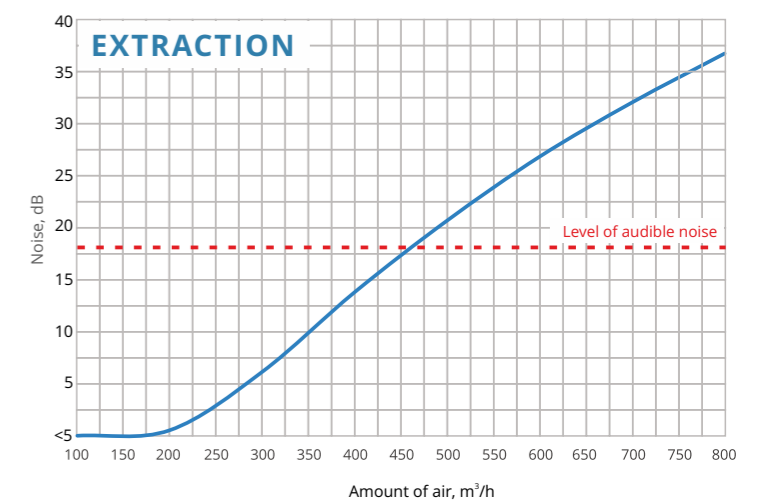
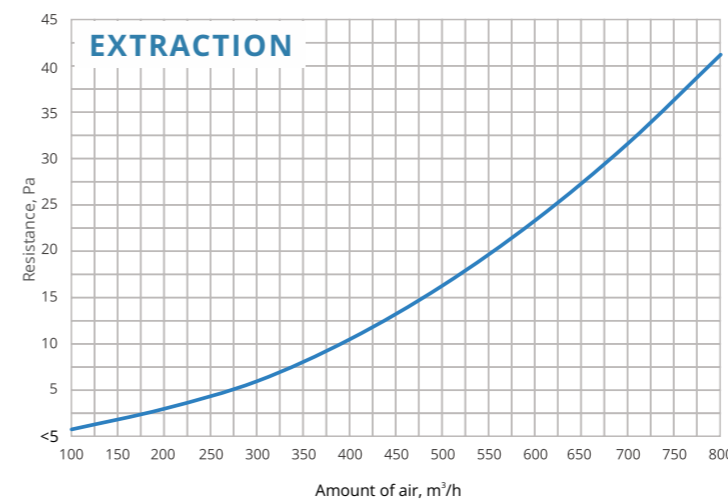
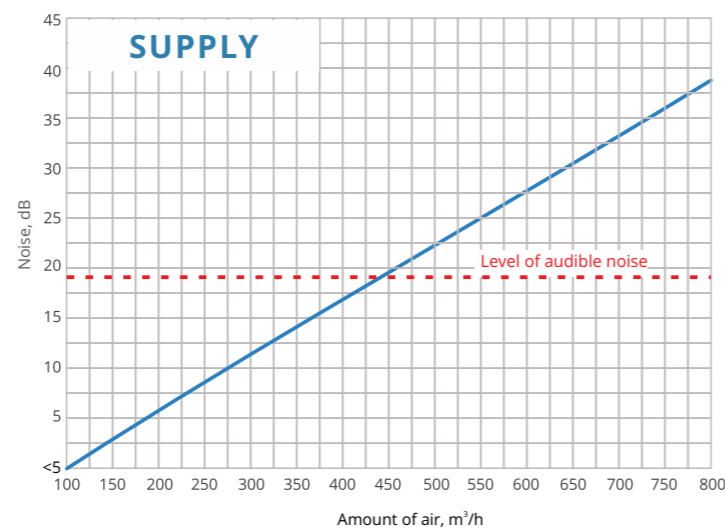
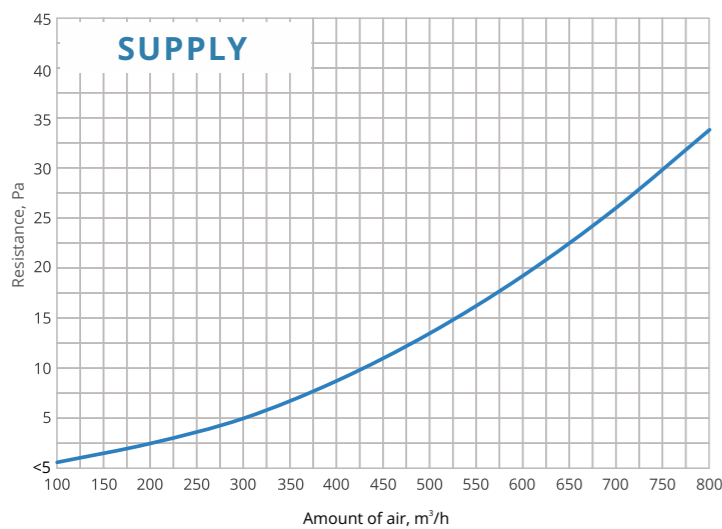

LINE 3/12

SLOT DIFFUSER

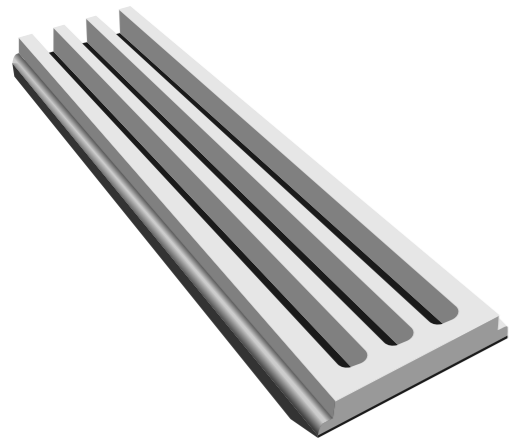

3
AMOUNT OF SLOTS

12 mm
WIDTH OF SLOT

4.085 kg
1 M. LENGTH DIFFUSER WEIGHT
WITHOUT PACKAGING (NET)

625 / 1000 / 1250
STANDARD SLOT LENGTH (MM)

Steel punched sheet. Distributes the air supply through the diffuser.

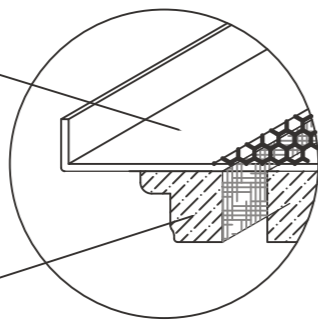

Gypsum mix segment. Sanded, puttied, painted. Suitable for all operations in combination with surface finishing

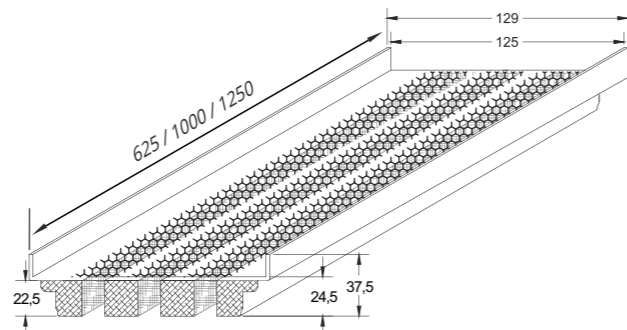
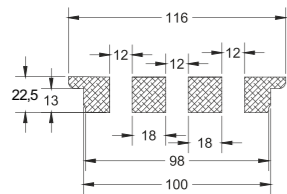

Slim version of this diffuser is characterized by lightness and elegance. It accomplishes the greatest technical tasks without obscuring the interior, causing noise or discomfort to residents

PERCEPTIBLE AIRSPEED $L_{0,2}(m)$ DISTANCE

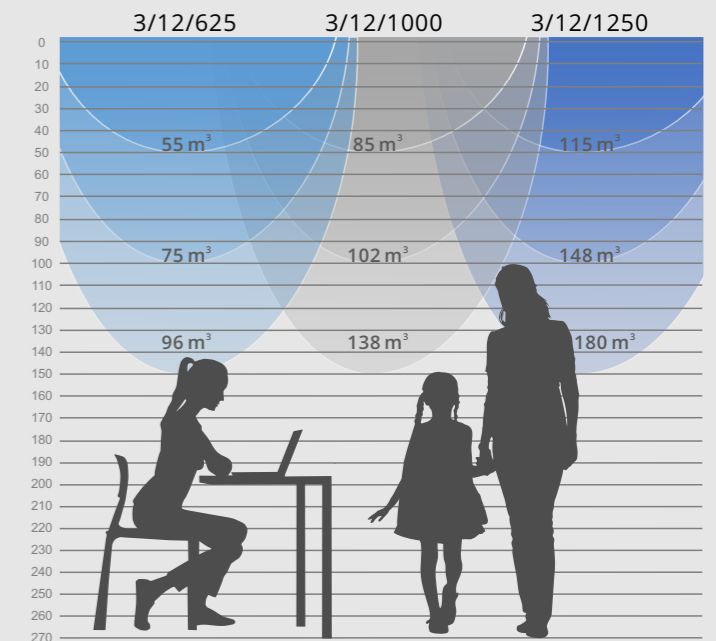

Airflow perceptible with the Line diffuser at a height of 2.70 m

PERCEPTIBLE AIRSPEED REACH LIMIT

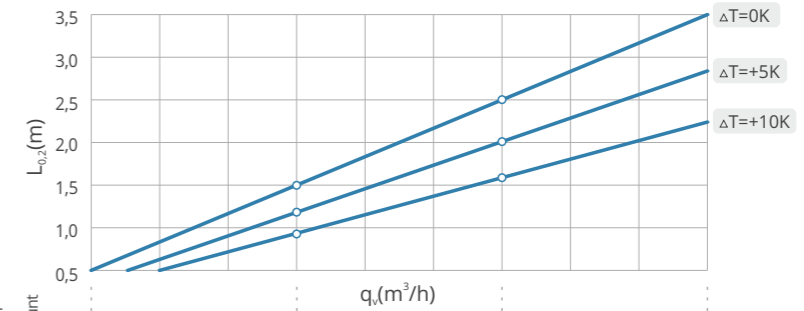

Order code:

Order code	625	1000	1250	180
LINE 625 3 12	55	96	137	180
LINE 1000 3 12	85	138	191	245
LINE 1250 3 12	115	180	245	310
LINE 625 3 18	55	111	167	225
LINE 1000 3 18	85	158	231	305
LINE 1250 3 18	115	205	295	385

Airborne noise and resistance, 1 m.

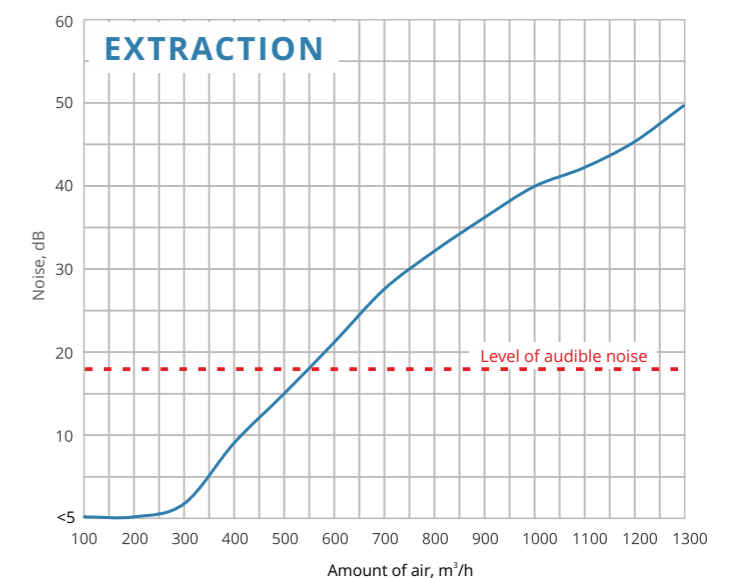
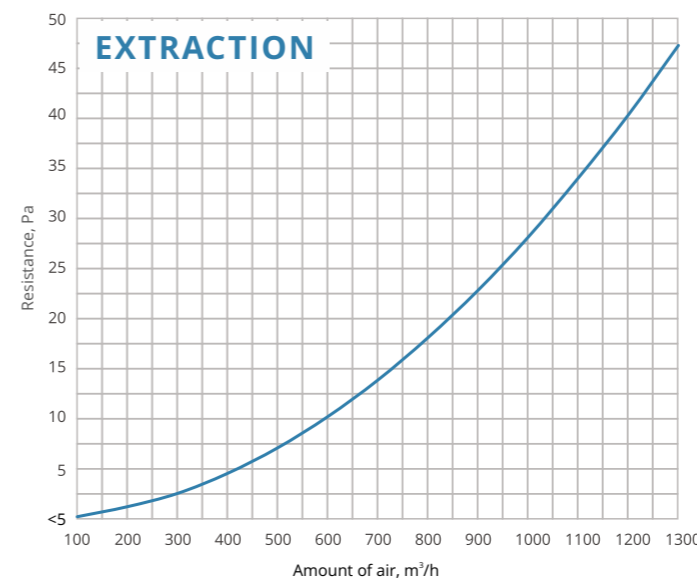
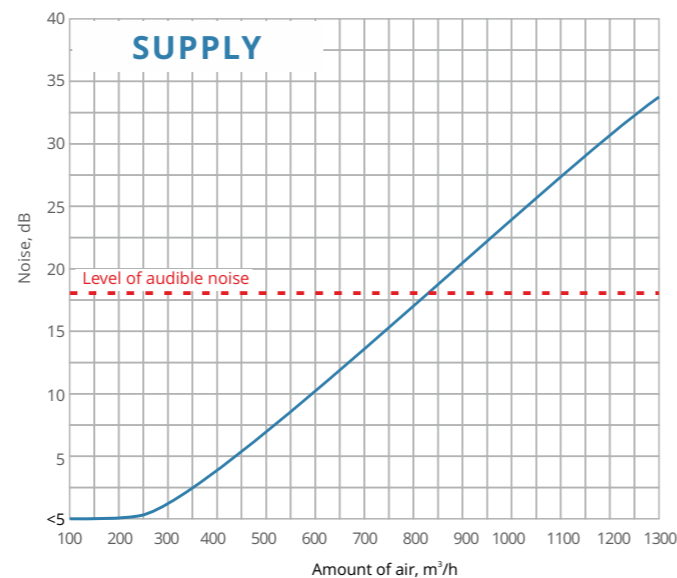
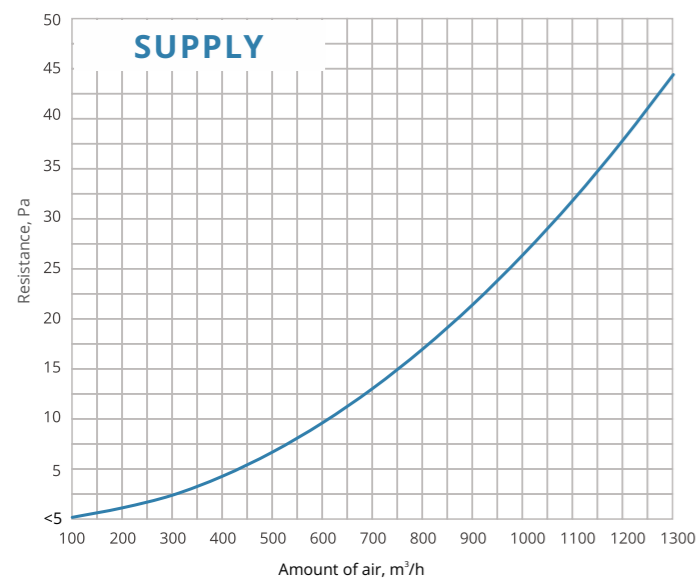

CIRCLE

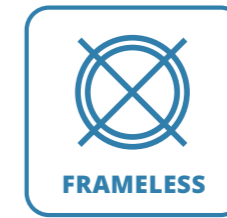

Frameless CIRCLE diffusers are the most versatile solution for every room and interior design style. It is the most popular choice, stylistically completely non-binding, blending perfectly with the environment.

Like all Ventmann air distributors, products in the CIRCLE line can be plastered together with the wall or the ceiling and can be painted with the same paint as the entire surface. All CIRCLE standard models can be adapted to your needs:

- 100mm or 125mm - these are the smallest standard connection nozzle diameters you can select.
- 160mm - this is the medium diameter of the standard connection nozzle that you can select.
- 200mm or 250mm - these are the largest standard connection nozzle diameters that you can select.

Multiple beautiful, sleek CIRCLE diffusers can be installed in a single room. You can order one of the standard CIRCLE diffuser sizes simply by filling out the order form below.

If your market requires specific sizes of CIRCLE diffusers - we can help you.

Fill out the order form below and select a bespoke order. Our consultants will contact you and together we will discuss the fulfilment of your order.

We also invite you to get acquainted in detail with the technical information of CIRCLE model diffuser, which you can do by reading through our catalogue.

Finally, to witness how easy it is to install CIRCLE diffusers, we invite you to watch our product showcase video.

Ventmann - your choice of air elegance.

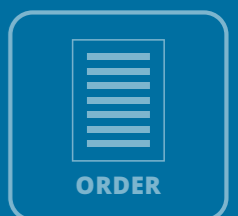
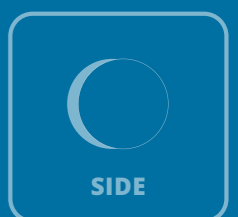
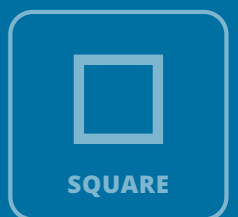
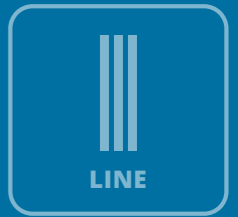

Installation:
video instructions
 YouTube



Download a digital
version of the catalog
 Download

CIRCLE 100/125

ROUND DIFFUSER



100/125 mm
DIAMETER OF COUPLING SLEEVE

2.60 kg
WEIGHT WITHOUT PACKAGING (NET)

Order code for 100 ø: **CIRCLE 100**
Hole diameter

Order code for 125 ø: **CIRCLE 125**
Hole diameter

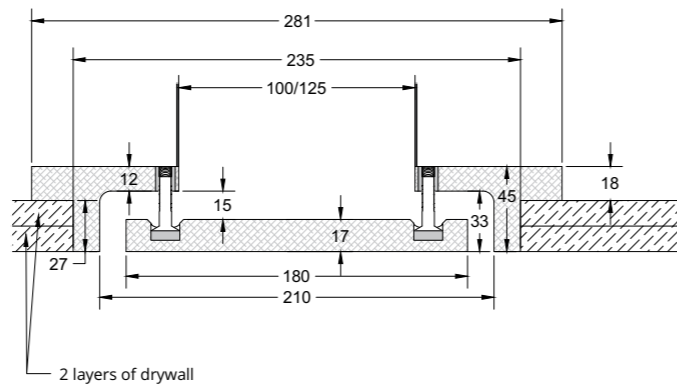
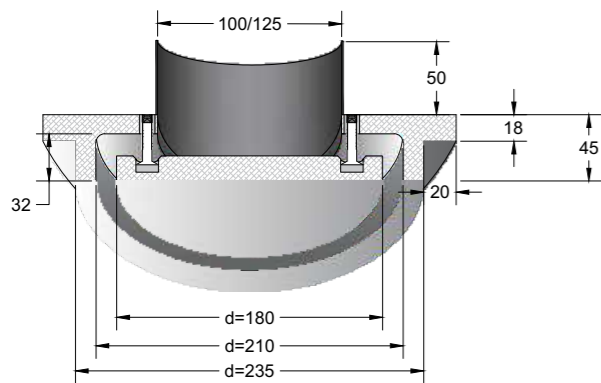

The round slot CIRCLE diffuser is ideally suited to a variety of room sizes. Can be used for both air supply and air extraction.

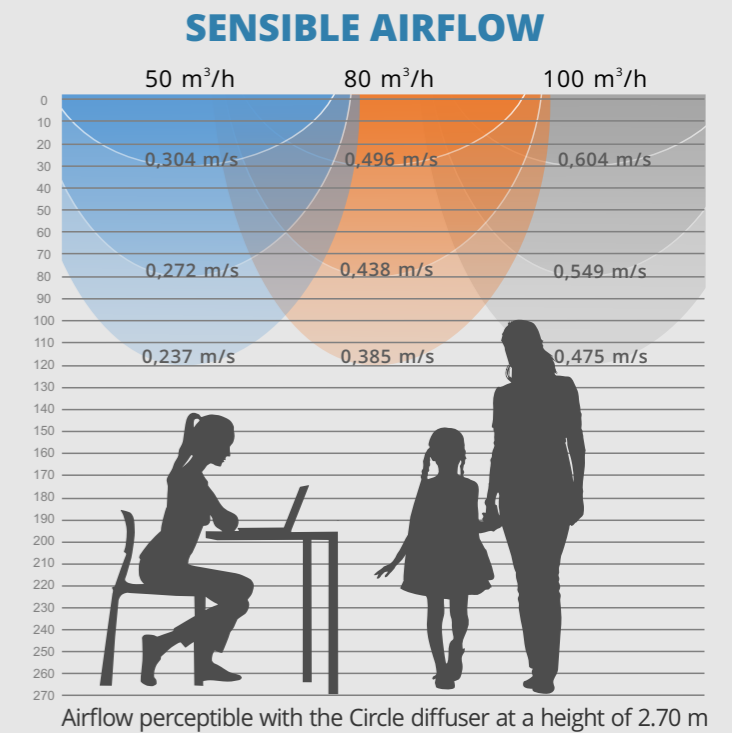

Air velocity at distance from diffuser

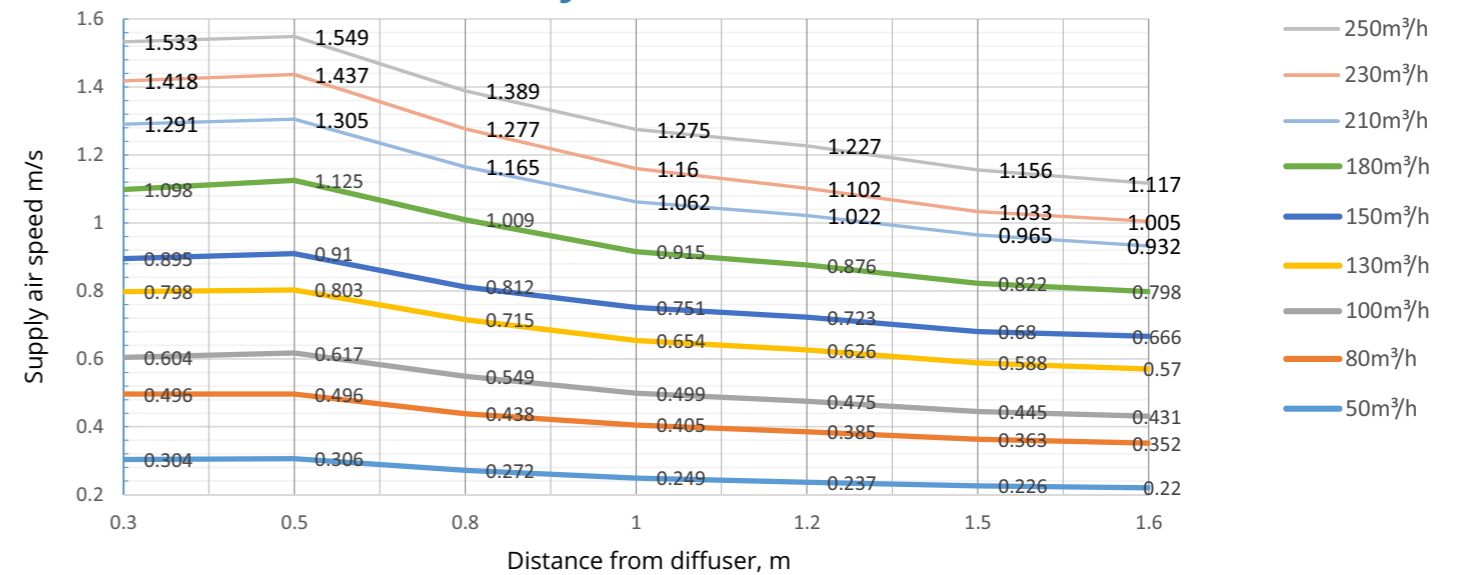

Airborne noise and resistance, 1 m.

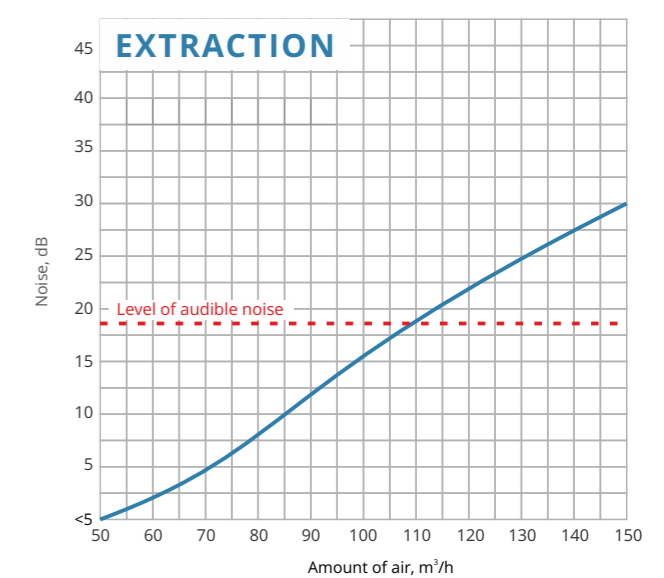
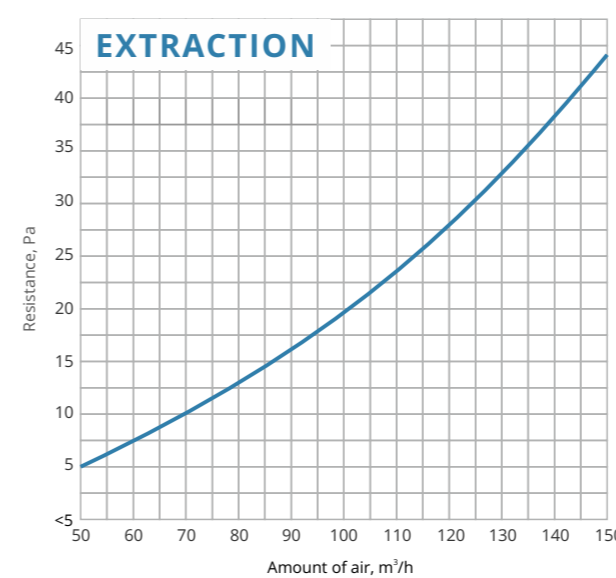
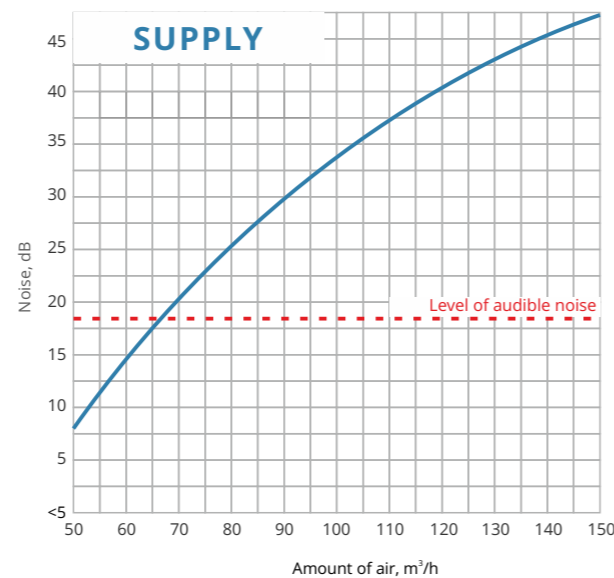
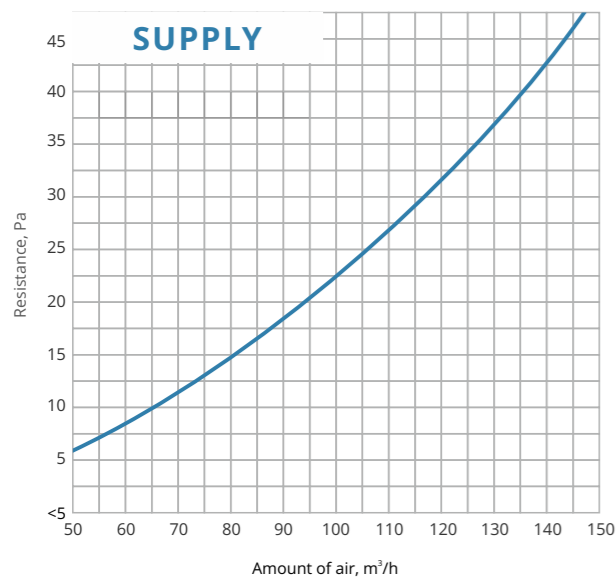

SQUARE

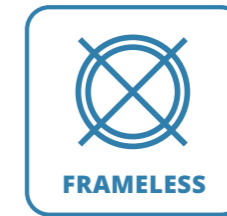

SQUARE diffusers are so much more than just another air distributor. They are minimalist interior elements that will accentuate the precise lines and rigid angles of an interior design. Toss aside the ventilation grille. You will no longer have to think about where to hide it, because from now on, air distributors are an integral part of the interior design.

SQUARE ventilation diffusers are also a practical solution. They are the first diffusers on the market that are mounted at the same time as the walls or ceilings and can be painted with the same paint. In addition, even standard SQUARE models can be adapted to your needs:

- 100mm or 125mm - these are the standard connection nozzle diameters that you can select.
- Industrial strengths magnets - the diffuser cap is supported by magnets that do not lose their strength for 95 years.

Due to their strict shape, multiple such diffusers can be installed in a single room. You can order one of the standard SQUARE diffuser sizes simply by filling out the order form below.

If you are looking for non-standard interior details for your project, or your market requires specific SQUARE diffuser sizes - we can help you.

Fill out the order form below and select a bespoke order. Our consultants will contact you and together we will discuss the fulfilment of your order.

We also invite you to get acquainted in detail with the technical information of SQUARE model diffuser, which you can do by reading through our catalogue.

Finally, to witness how easy it is to install SQUARE diffusers, we invite you to watch our product showcase video.

Ventmann – your choice of air elegance.

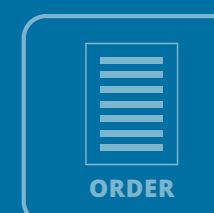
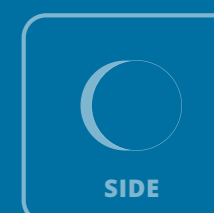
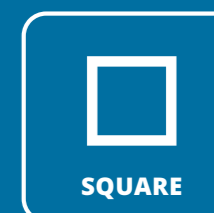
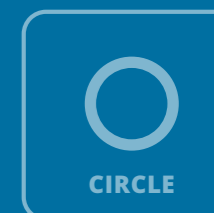
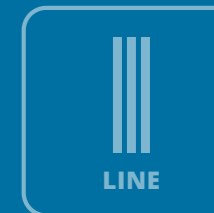

Installation:
video instructions
 YouTube



Download a digital
version of the catalog
 Download

SQUARE 100/125

SQUARE-SLOT

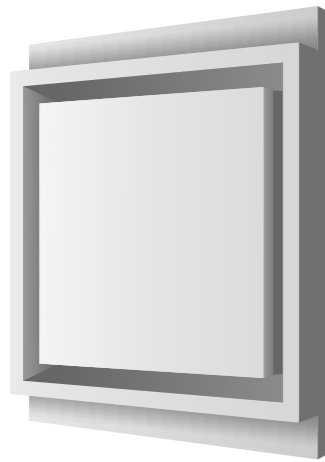

100/125 mm
DIAMETER OF COUPLING SLEEVE

2.40 kg
WEIGHT WITHOUT PACKAGING (NET)

Order code for 100 ø: **SQUARE 100**
Hole diameter

Order code for 125 ø: **SQUARE 125**
Hole diameter

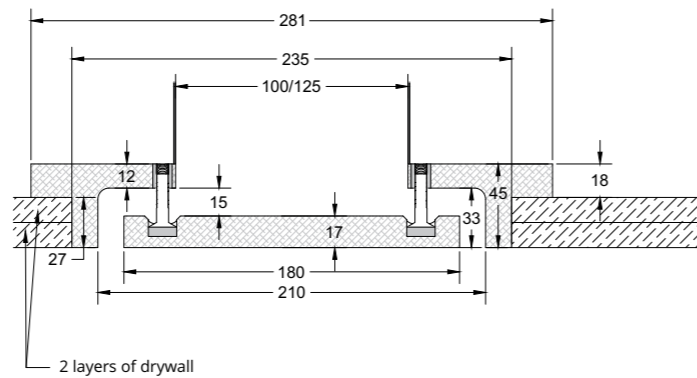
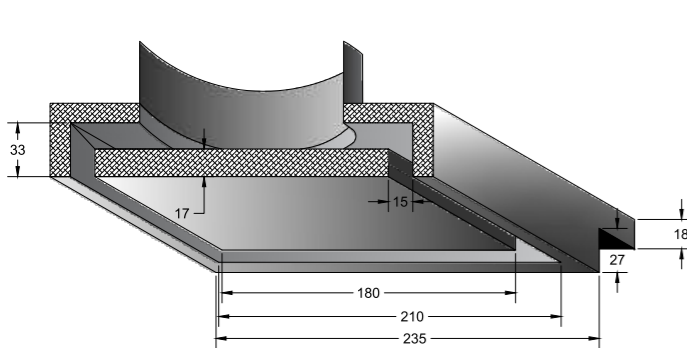

Square-slot frameless diffuser Square is ideal for a variety of room sizes. Can be used for both air supply and air extraction. It is possible to use several units in one room. Can be manufactured with a 100 mm connection pipe.

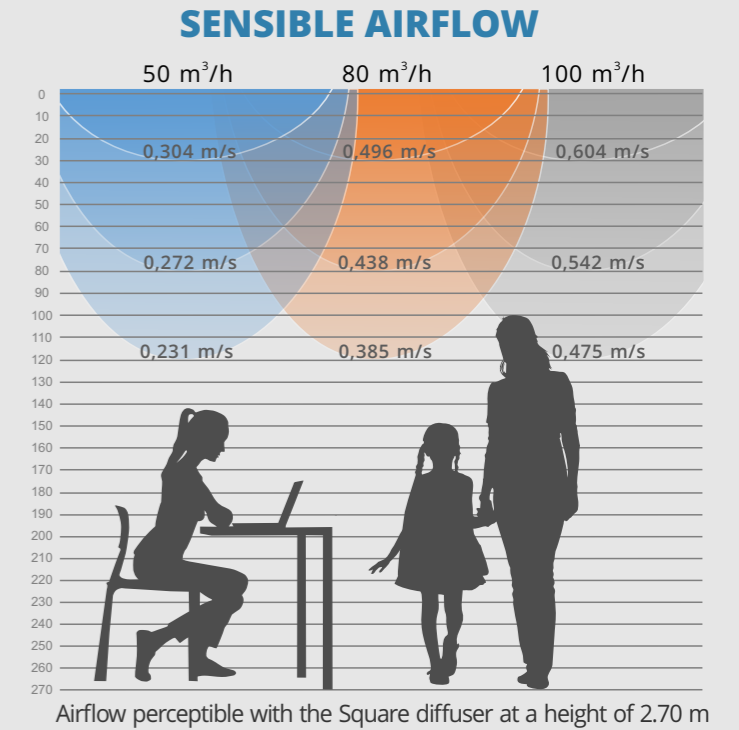

Air velocity at distance from diffuser

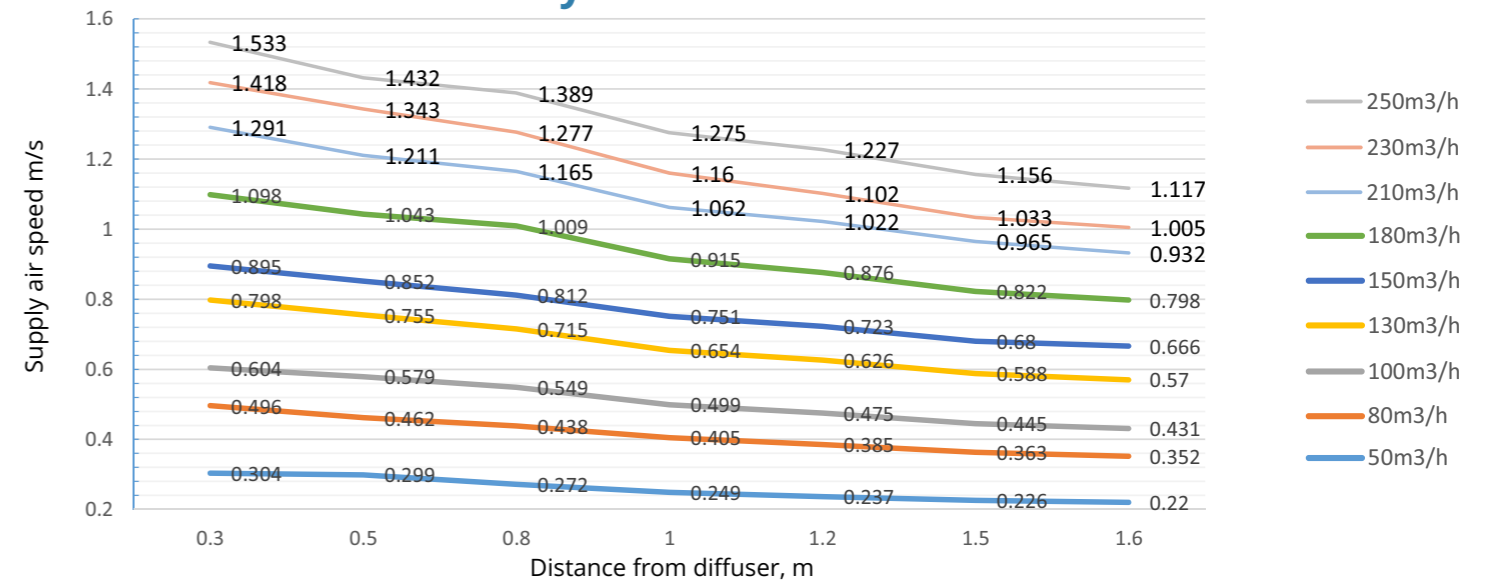

Airborne noise and resistance, 1 m.

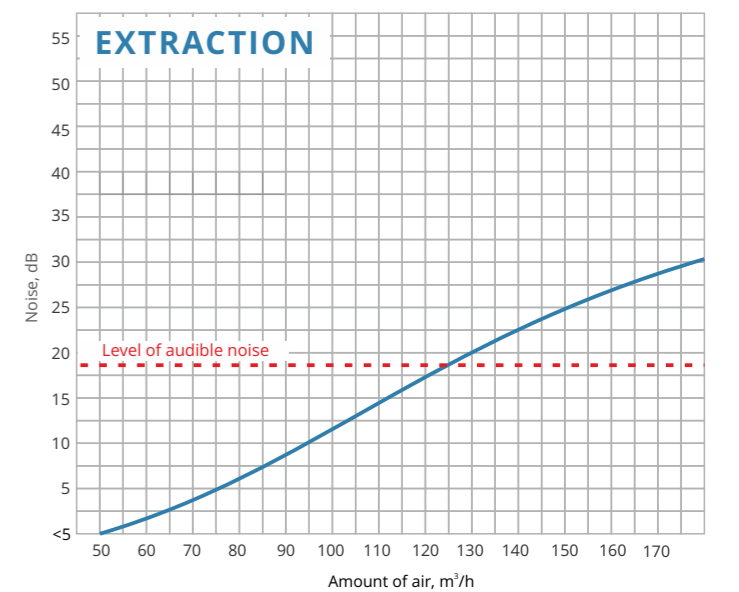
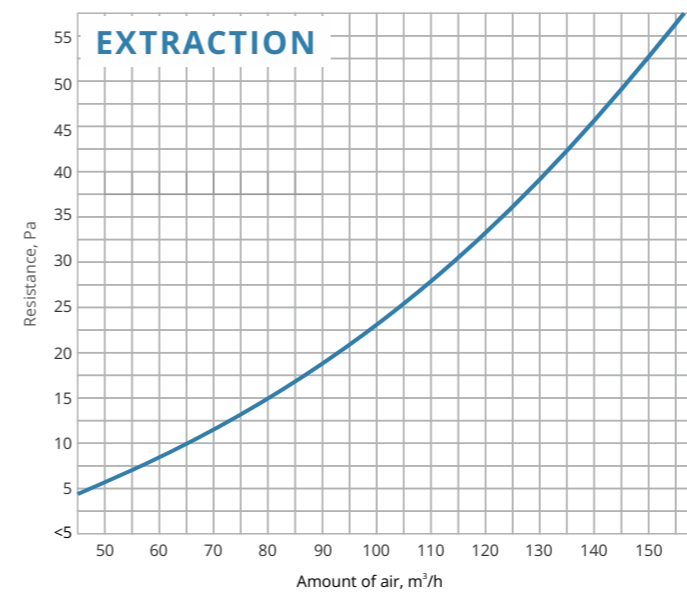
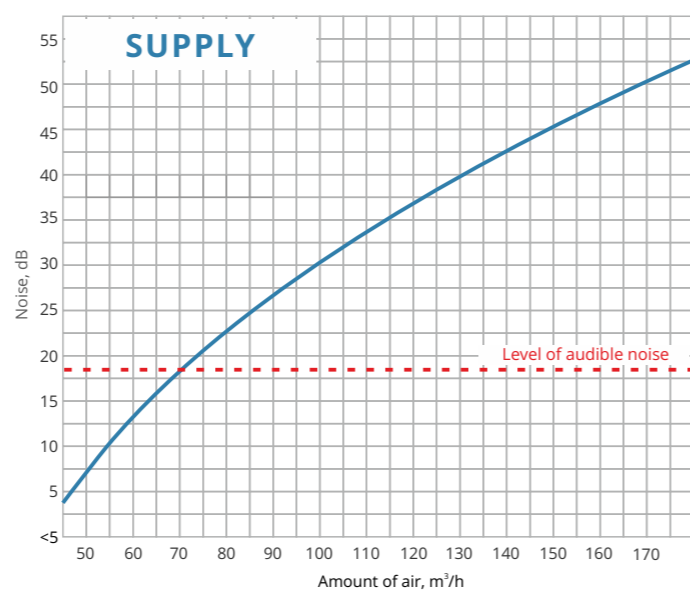
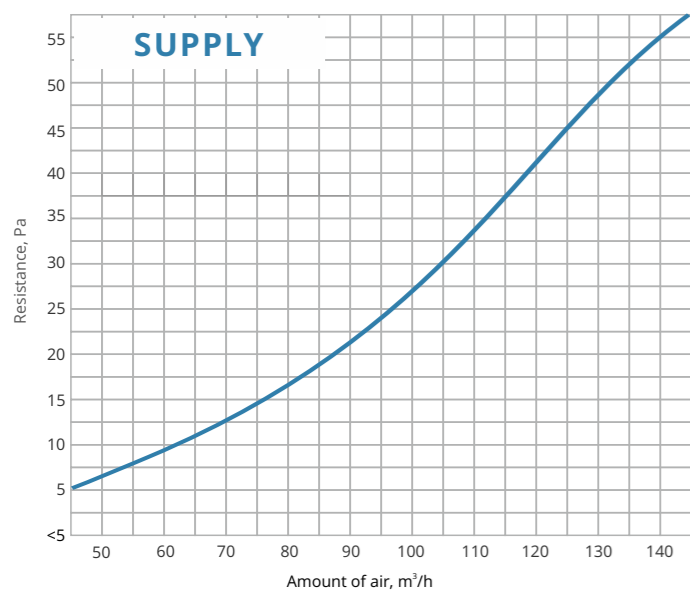

SIDE

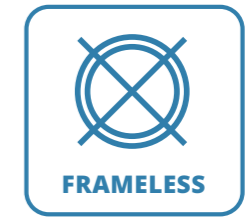

The unique design of SIDE diffuser models ensures air distribution on the plane surface on which they are mounted. SIDE duct diffusers are also attractive as interior design solutions - their caps can be mounted in a circular or a square shape. It is also a practical solution. All Ventmann diffusers are the first on the market that can be plastered and painted together with the entire surface. In addition, even standard SIDE models can be adapted to your needs:

- Round or Square diffuser - you can choose the shape of the cap per your or your customer's design requirements.
- 100mm or 125mm - these are the smallest standard connection nozzle diameters you can select.
- 160mm - this is the medium diameter of the standard connection nozzle that you can select.
- 250mm - this is the maximum diameter of the standard connection nozzle that you can select.

You can order these beautiful, sleek, circular; or strict, precise, square SIDE variants right here by filling out the order form below.

If your project requires specific interior solutions or your market requires specific SIDE diffuser sizes - we can help you.

Fill out the order form below and select a bespoke order. Our consultants will contact you and together we will discuss the fulfilment of your order.

We also invite you to get acquainted in detail with the technical information of SIDE model diffuser, which you can do by reading through our catalogue.

Finally, to witness how easy it is to install SIDE diffusers, we invite you to watch our product showcase video.

Ventmann – your choice of air elegance.

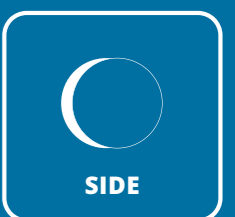
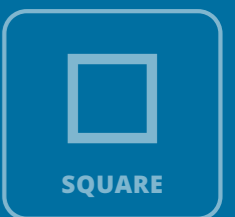

Installation:
video instructions
 YouTube



Download a digital
version of the catalog
 Download

SIDE 100/125

WALL DIFFUSER

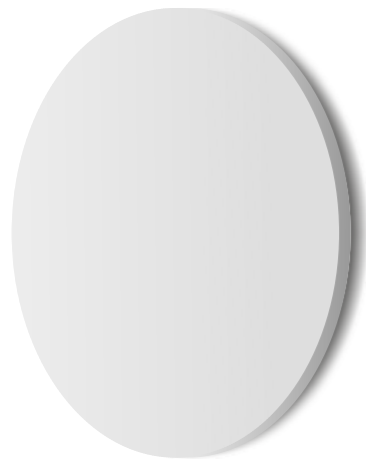

SIDE ROUND



SIDE SQUARE

100/125 mm
DIAMETER OF COUPLING SLEEVE

2.735 kg
WEIGHT WITHOUT PACKAGING (NET)

Order code for 100 ø:
SIDE 0 100
Corners Hole diameter
Order code for 125 ø:
SIDE 0 125
Corners Hole diameter

Order code for 100 ø:
SIDE 4 100
Corners Hole diameter
Order code for 125 ø:
SIDE 4 125
Corners Hole diameter

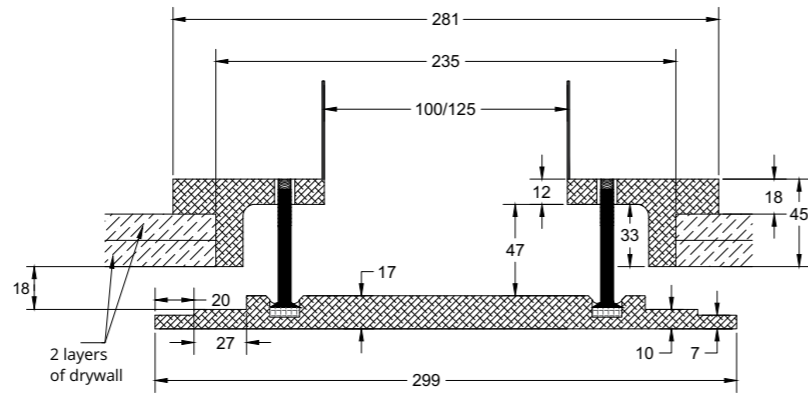
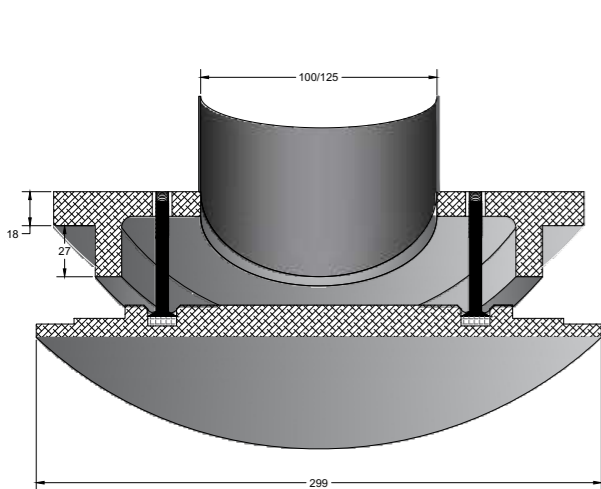

Due to its unique design, this diffuser ensures air diffusion in a horizontal plane when installed in the ceiling or in a vertical plane when installed in a wall. This is why this diffuser can be mounted above the seating, desk without causing discomfort to the occupant.

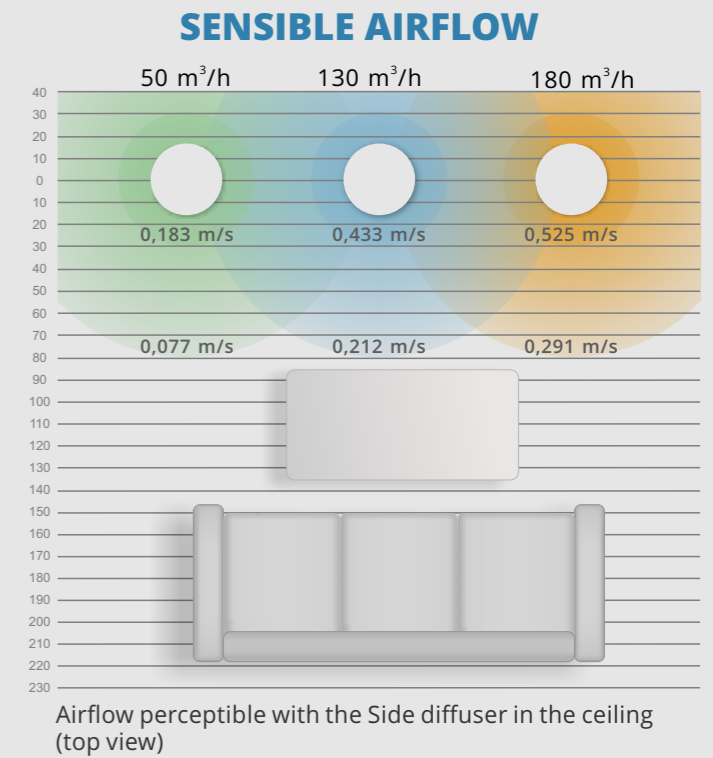

Air velocity at distance from diffuser

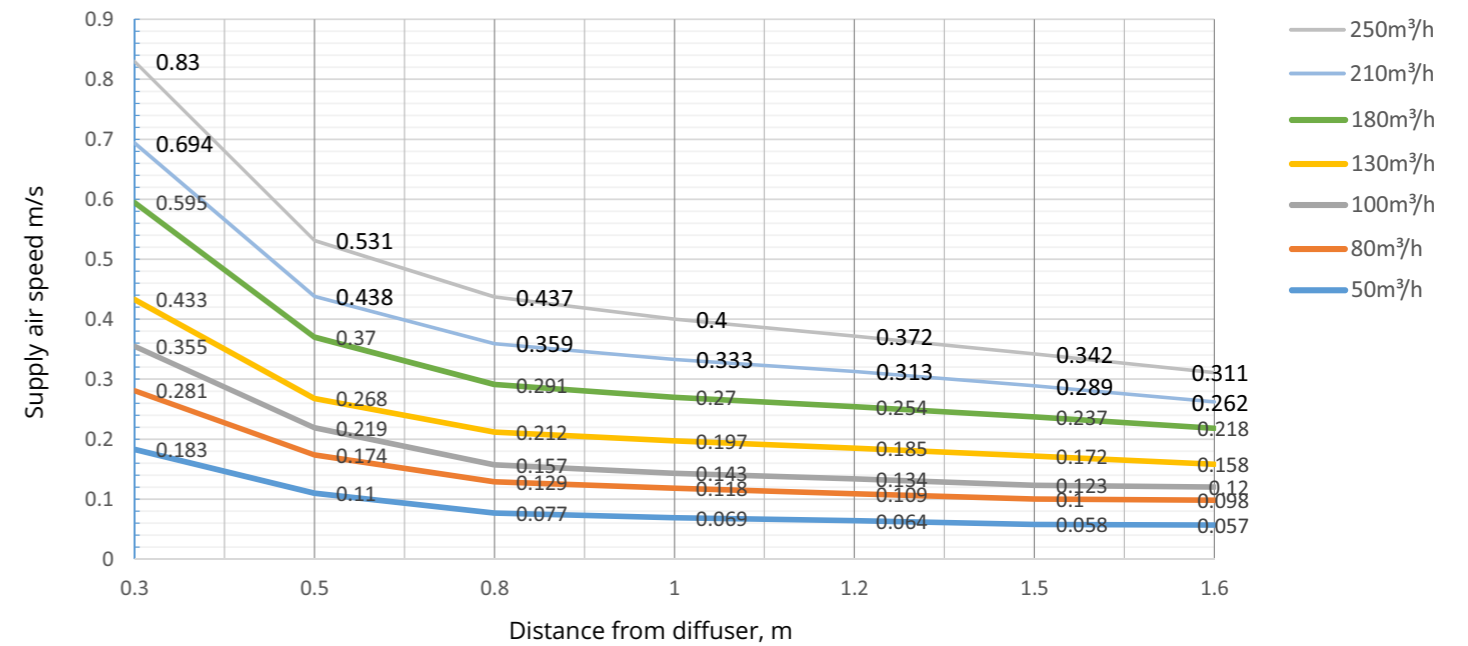

Airborne noise and resistance, 1 m.

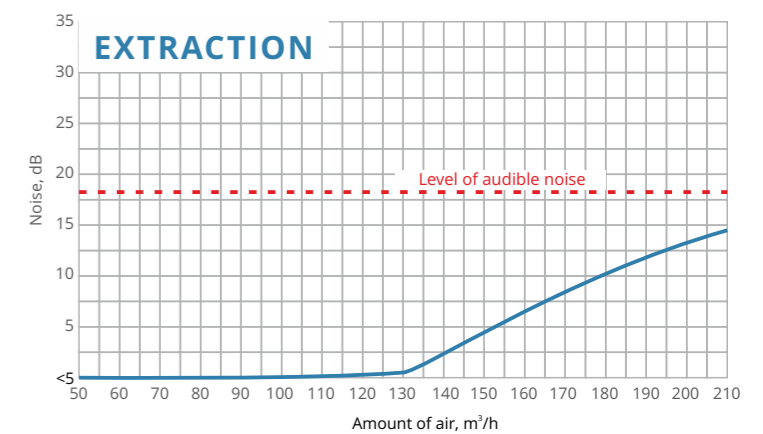
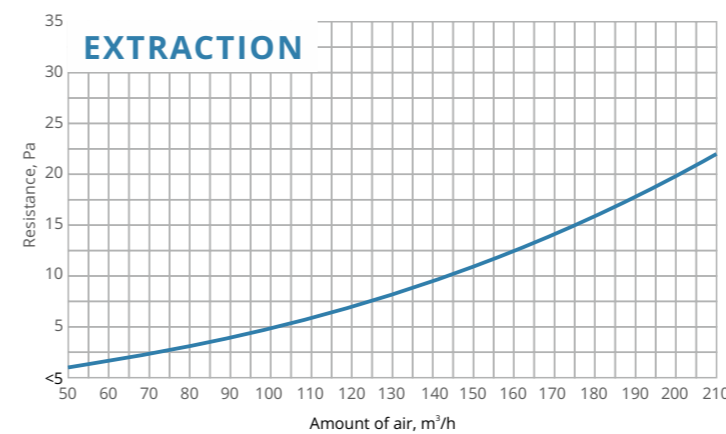
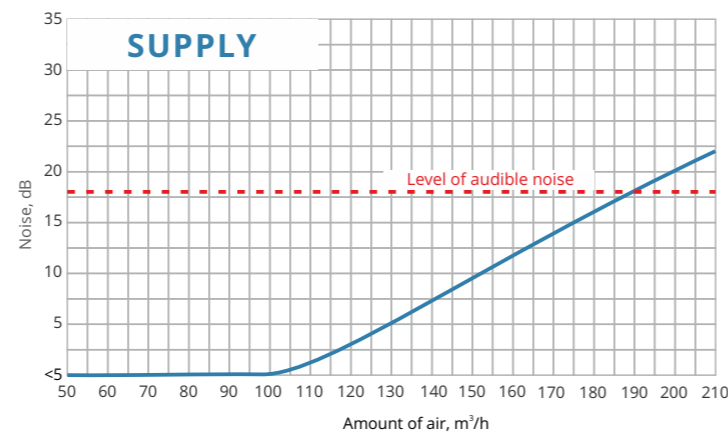
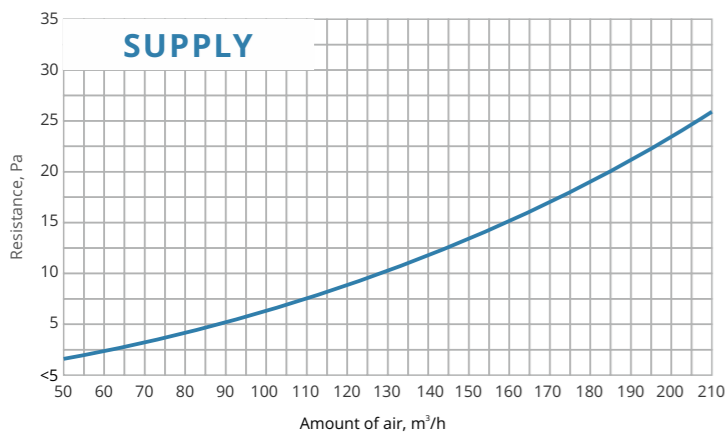

FRAMELESS DIFFUSERS ORDER CODES

Same color parts fit together!



1 SLOT LINE DIFFUSER

ORDER CODE	SLOT LENGTH	SLOTS AMOUNT	SLOT WIDTH	PAGE
LINE625112	625	1	12	5, 6
LINE1000112	1000	1	12	5, 6
LINE1250112	1250	1	12	5, 6
LINE625118	625	1	18	7, 9
LINE1000118	1000	1	18	7, 9
LINE1250118	1250	1	18	7, 9



2 SLOTS LINE DIFFUSER

ORDER CODE	SLOT LENGTH	SLOTS AMOUNT	SLOT WIDTH	PAGE
LINE625212	625	2	12	9, 10
LINE1000212	1000	2	12	9, 10
LINE1250212	1250	2	12	9, 10
LINE625218	625	2	18	11, 12
LINE1000218	1000	2	18	11, 12
LINE1250218	1250	2	18	11, 12



3 SLOTS LINE DIFFUSER

ORDER CODE	SLOT LENGTH	SLOTS AMOUNT	SLOT WIDTH	PAGE
LINE625312	625	3	12	15, 16
LINE1000312	1000	3	12	15, 16
LINE1250312	1250	3	12	15, 16
LINE625318	625	3	18	17, 18
LINE1000318	1000	3	18	17, 18
LINE1250318	1250	3	18	17, 18

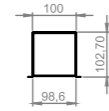

ACOUSTIC JUNCTION BOXES 75MM

ORDER CODE	CONNECTION DIAMETER	SLOT LENGTH	SLOTS AMOUNT	PAGE
GTG75625	75	625	1/2	13, 14
GTG751000	75	1000	1/2	13, 14
GTG751250	75	1250	1/2	13, 14

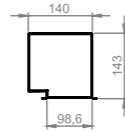

ACOUSTIC JUNCTION BOXES 125MM

ORDER CODE	CONNECTION DIAMETER	SLOT LENGTH	SLOTS AMOUNT	PAGE
GTG125625	125	625	1/2	13, 14
GTG1251000	125	1000	1/2	13, 14
GTG1251250	125	1250	1/2	13, 14

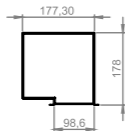

ACOUSTIC JUNCTION BOXES 160MM

ORDER CODE	CONNECTION DIAMETER	SLOT LENGTH	SLOTS AMOUNT	PAGE
GTG160625	160	625	1/2	13, 14
GTG1601000	160	1000	1/2	13, 14
GTG1601250	160	1250	1/2	13, 14

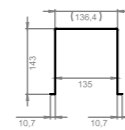

ACOUSTIC JUNCTION BOXES 125MM

ORDER CODE	CONNECTION DIAMETER	SLOT LENGTH	SLOTS AMOUNT	PAGE
GTG3125625	125	625	3	19, 20
GTG31251000	125	1000	3	19, 20
GTG31251250	125	1250	3	19, 20

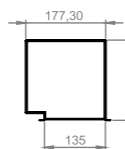

ACOUSTIC JUNCTION BOXES 160MM

ORDER CODE	CONNECTION DIAMETER	SLOT LENGTH	SLOTS AMOUNT	PAGE
GTG3160625	160	625	3	19, 20
GTG31601000	160	1000	3	19, 20
GTG31601250	160	1250	3	19, 20

FRAMELESS DIFFUSERS ORDER CODES

Same color parts fit together!



SQUARE DIFFUSER

ORDER CODE	CONNECTION DIAMETER	PAGE
SQUARE100	100	31,32
SQUARE125	125	31,32



CIRCLE DIFFUSER

ORDER CODE	CONNECTION DIAMETER	PAGE
CIRCLE100	100	23,24
CIRCLE125	125	23,24
CIRCLE160	160	25,26
CIRCLE200	200	27,28
CIRCLE250	250	27,28



ROUND SIDE DIFFUSER

ORDER CODE	CONNECTION DIAMETER	PAGE
SIDE0100	100	35,36
SIDE0125	125	35,36
SIDE0160	160	37,38
SIDE0200	200	39,40
SIDE0250	250	39,40



SQUARE SIDE DIFFUSER

ORDER CODE	CONNECTION DIAMETER	PAGE
SIDE4100	100	35,36
SIDE4125	125	35,36
SIDE4160	160	37,38
SIDE4200	200	39,40
SIDE4250	250	39,40



SIDE DIFFUSER BASE

ORDER CODE	CONNECTION DIAMETER	PAGE
SIDEBASE100	100	35,36
SIDEBASE125	125	35,36
SIDEBASE160	160	37,38
SIDEBASE200	200	39,40
SIDEBASE250	250	39,40

KONTAKTY

E-MAIL a TEL

info@smartsunsro.sk

+421 (02) 4329 1345

+421 948 891 999

ADRESA

Smartsun s.r.o. Budovateľská 29, 82108 Bratislava

Showroom: Strojársená 8, 90027 Bernolákovo

WEB

www.smartsunsro.sk

www.rekuperacia-brink.sk

www.airexcellent.sk

